

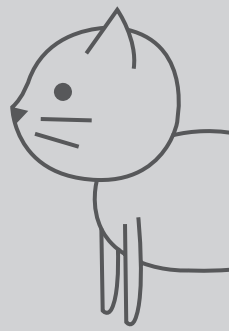

# KERBL Pet

#80912



A



M5\*50mm  
4PCS

B



M8\*32mm  
4PCS

C



1PC

D



1PC

E

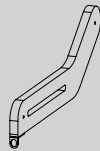

2PCS

F



1PC

G

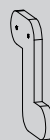

1PC

H



2PCS

I

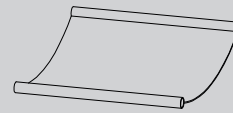

1PC

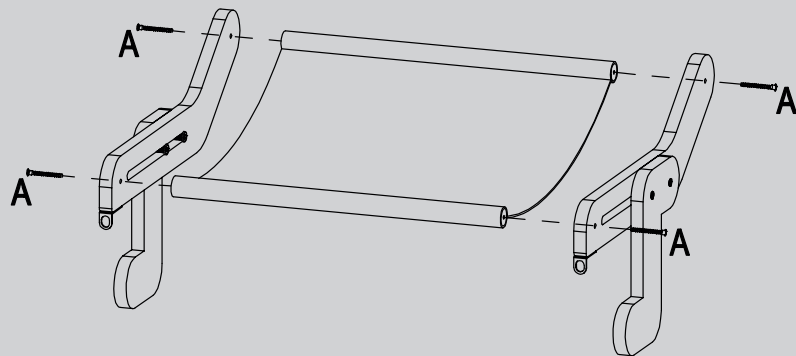
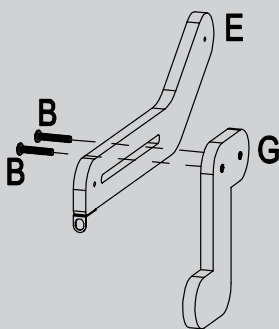
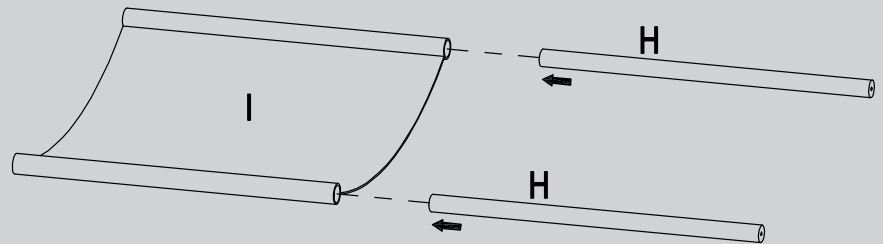
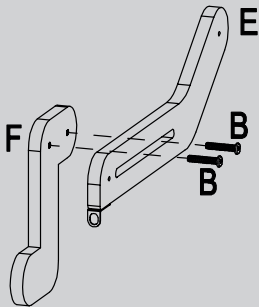

(DE) Bitte halten Sie die Reihenfolge der Arbeitsschritte 1,2,3,... von der Skizze ein. Bitte prüfen Sie im Vorfeld die Standfestigkeit ihres Möbelstücks!  
Achtung Kippgefahr!

(FR) Veuillez suivre la sequence du Workflow 1, 2, 3 ...comme vous pouvez le voir sur le schema. Veuillez vérifier au préalable la stabilité de votre meuble  
! Attention au risque de basculement ! (

(EN) Pls follow the sequence of the workflow 1,2,3,... as you can see on the draft. Please check the stability of your furniture in advance! Attention:  
Danger of tipping!

Albert Kerbl GmbH  
Felizenzell 9  
84428 Buchbach, Germany  
Tel. +49 8086 933 - 100  
Fax +49 8086 933 - 500  
E-Mail info@kerbl.de  
www.kerbl.de

Kerbl Austria Handels GmbH  
Wirtschaftspark 1  
9130 Poggersdorf  
Tel. +43 4224 81555  
Fax. +43 4224 81555-629  
E-Mail order@kerbl-austria.at  
www.kerbl-austria.at

Kerbl France Sarl  
3 rue Henri Rouby, B.P 46 Soultz  
68501 Guebwiller Cedex, France  
Tel. +33 3 89 62 15 00  
Fax +33 3 89 83 04 46  
E-Mail info@kerbl-france.com  
www.kerbl-france.com

Kerbl UK Limited  
8 Lands End Way  
Oakham, Rutland  
LE15 6RF UK  
Phone +44 01572 722558  
Fax +44 01572 757614  
E-Mail enquiries@kerbl.co.uk  
www.kerbl.co.uk